

A VIEW

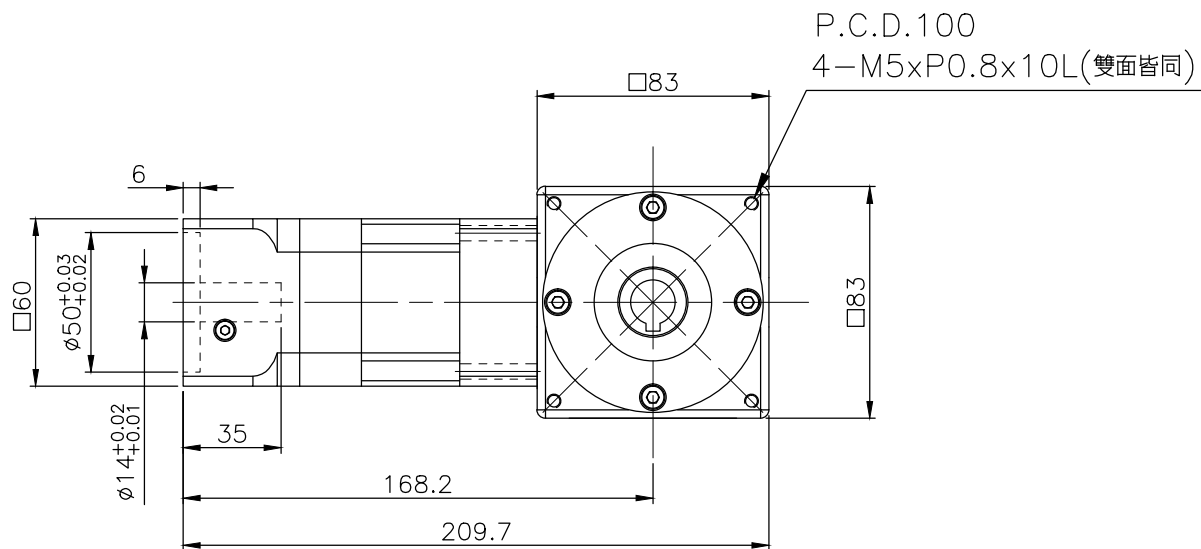

Material	
Treatment	
Hardness	

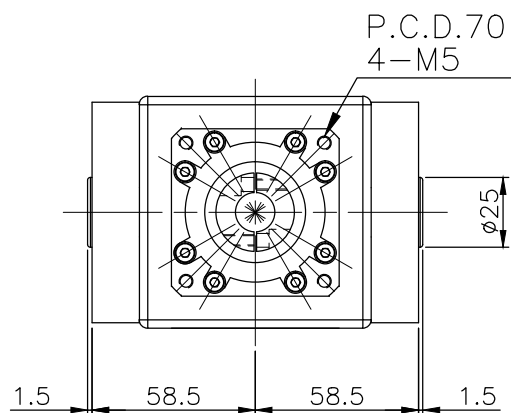

Pin Hong Technology co., Ltd

DWG.NO.	2019	REV.NO.	2019
PRT.NO.	RAM060-L2-XX-H-14-50-70-M5	Drawing	Aaron
Scale		Check	