

A VIEW

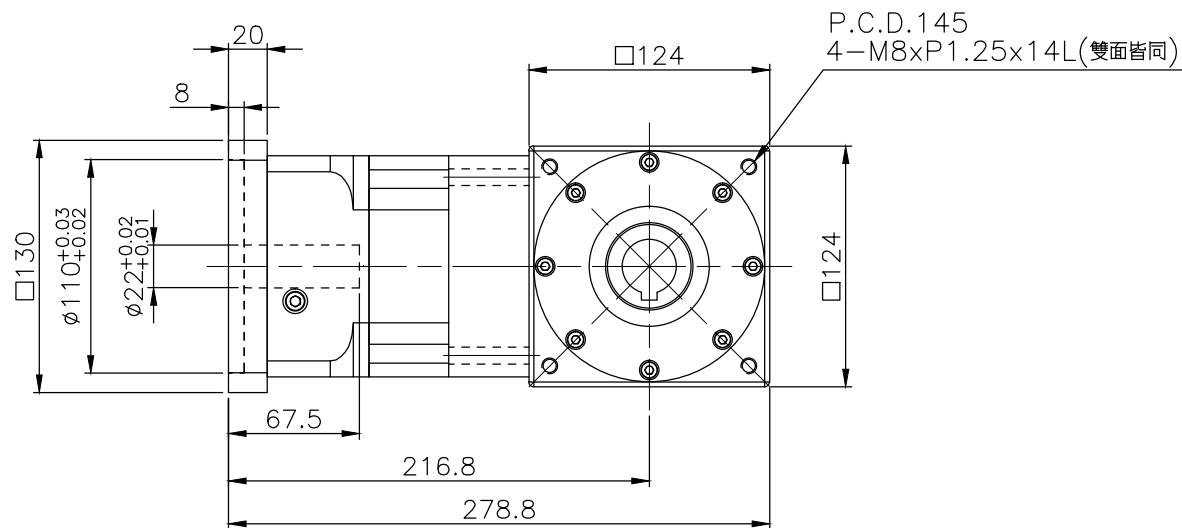

Material	
Treatment	
Hardness	

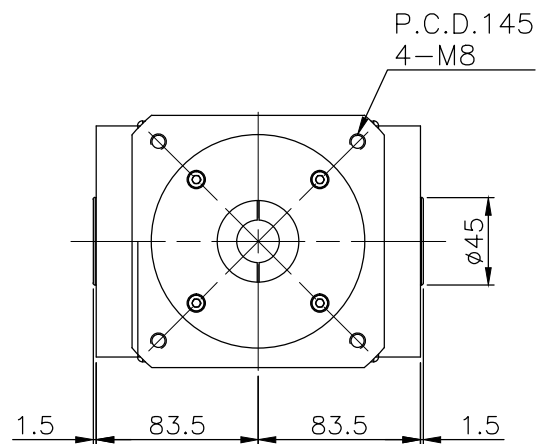

Pin Hong Technology co., Ltd

DWG.NO.	2019	REV.NO.	2019
PRT.NO.	RAM120-L1-XX-H-22-110-145-M8	Drawing	Aaron
Scale	連接法蘭	Check	